

US Energy and Carbon Flows 2006

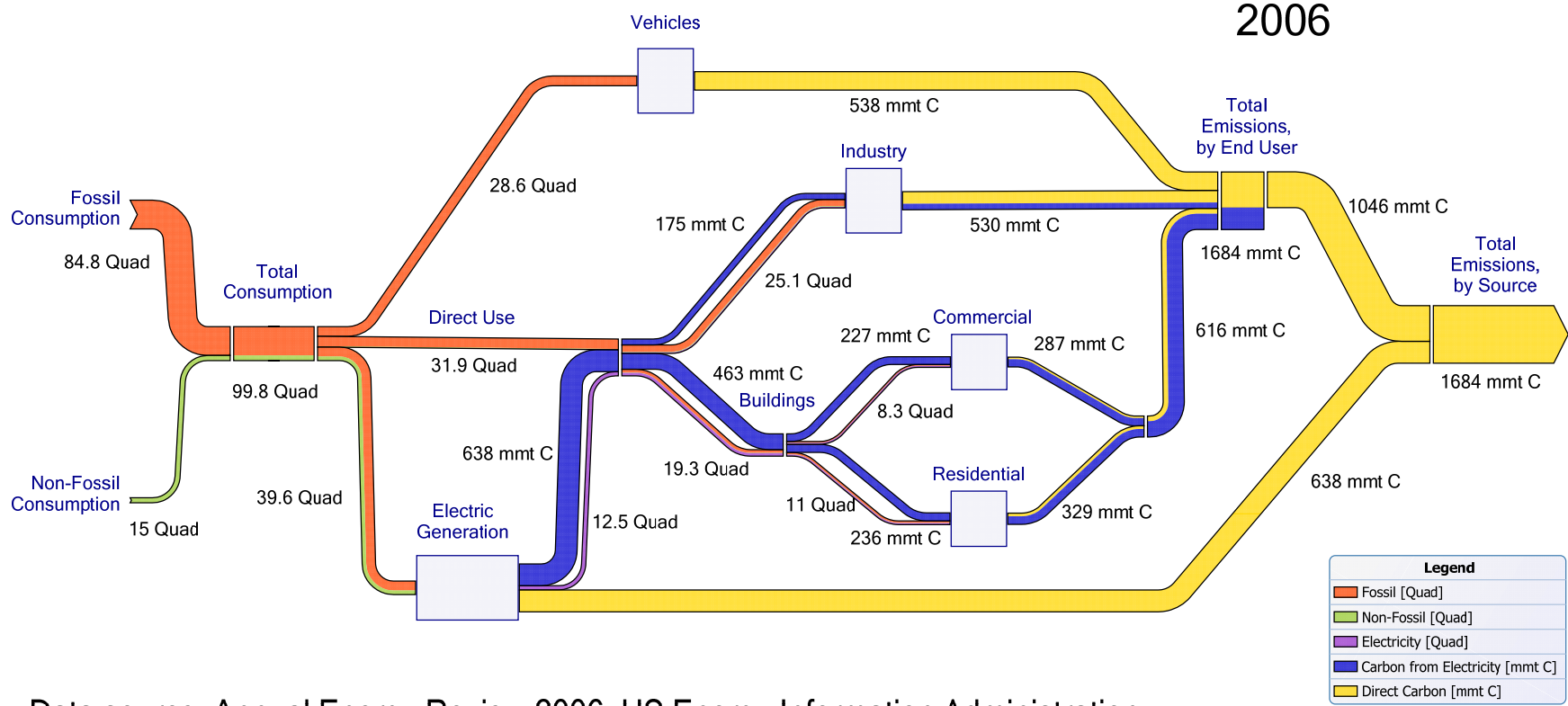

Data source: Annual Energy Review 2006, US Energy Information Administration

US Transportation Sector 2006

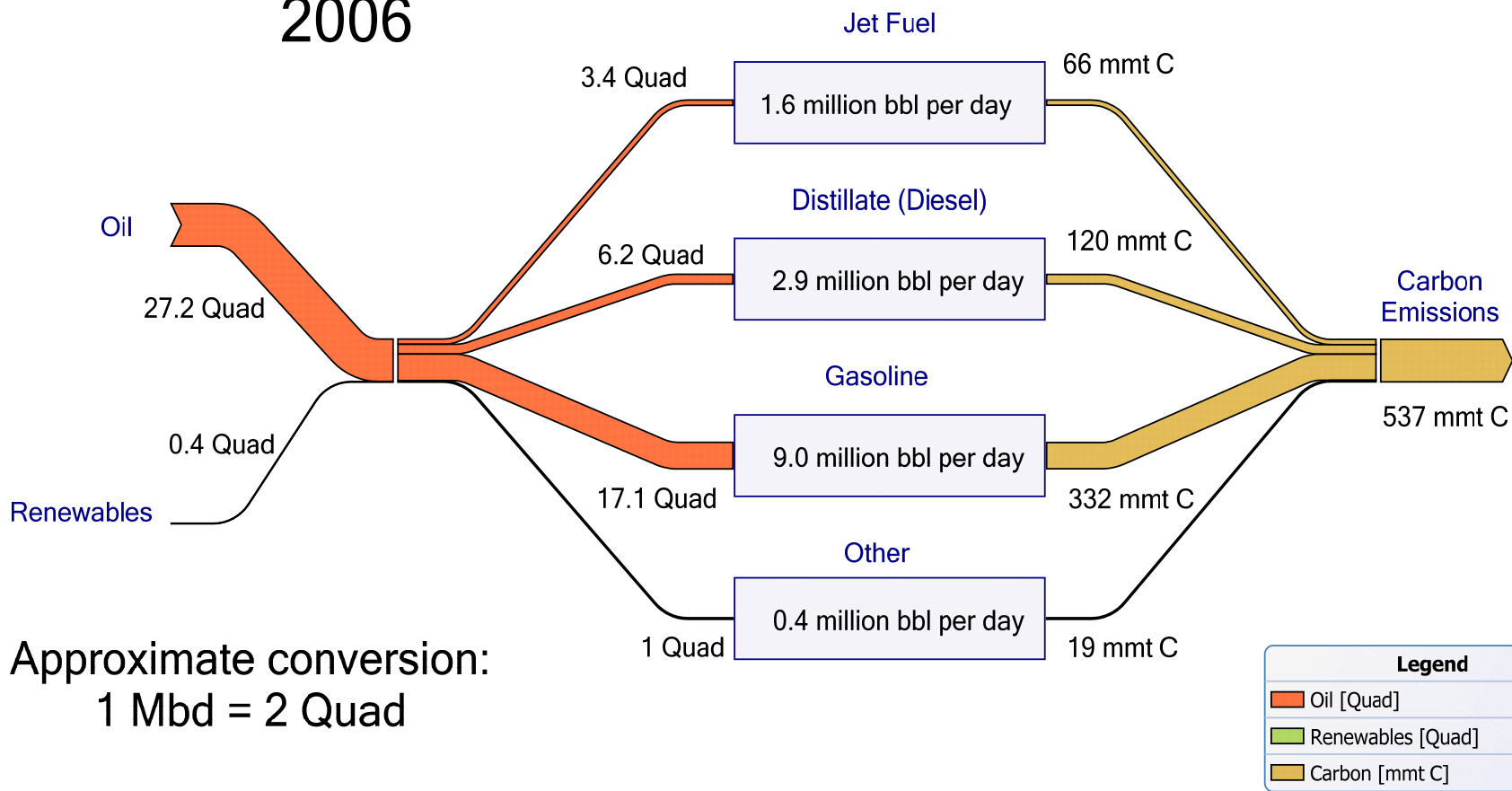

Data source: Annual Energy Review 2006, US Energy Information Administration

US Electricity Flows 2006

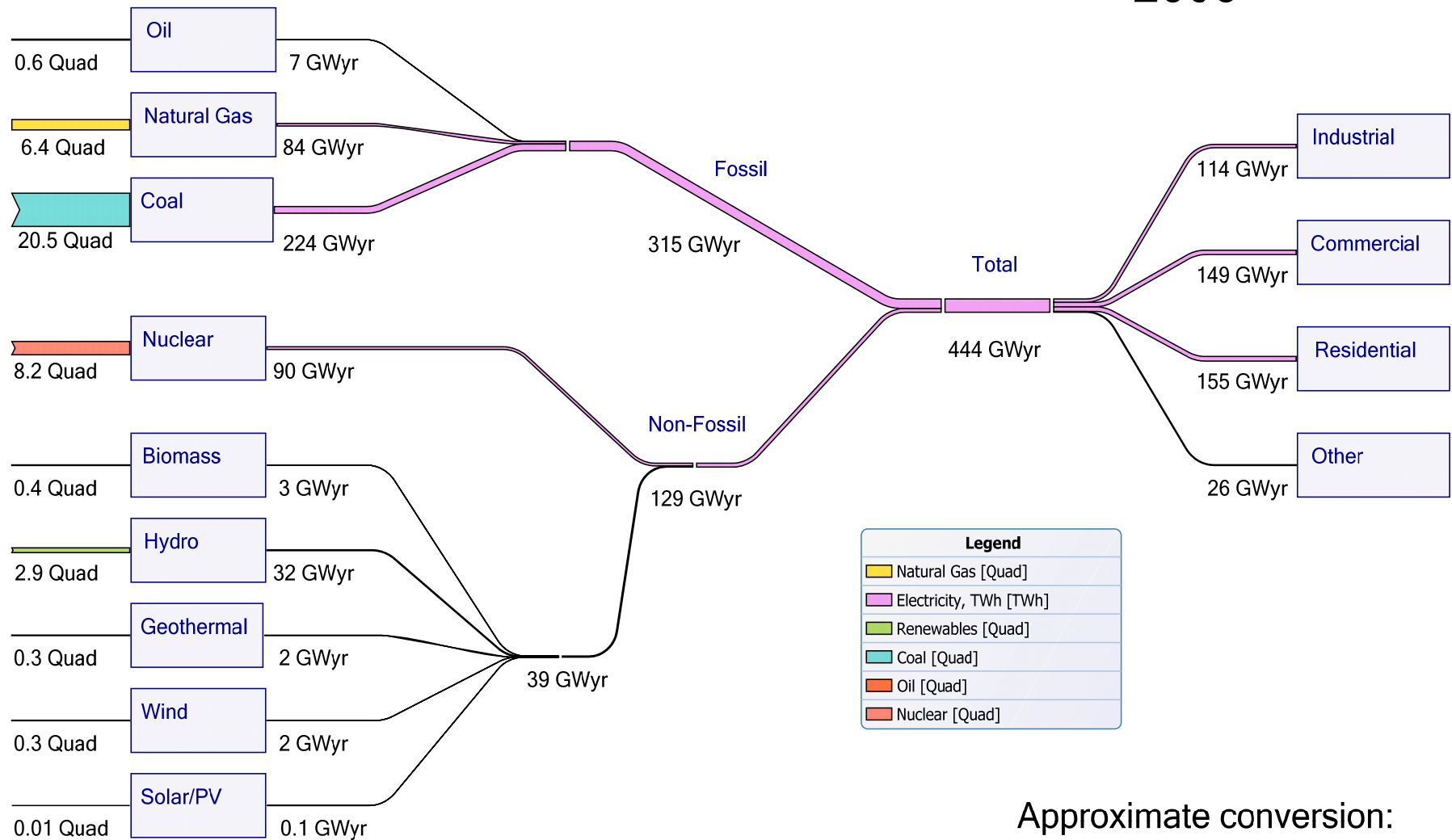

Approximate conversion:
1 Quad = 11 GWyr

Data source: Annual Energy Review 2006, Energy Information Administration

Electric Sector Capacity Utilization 2006

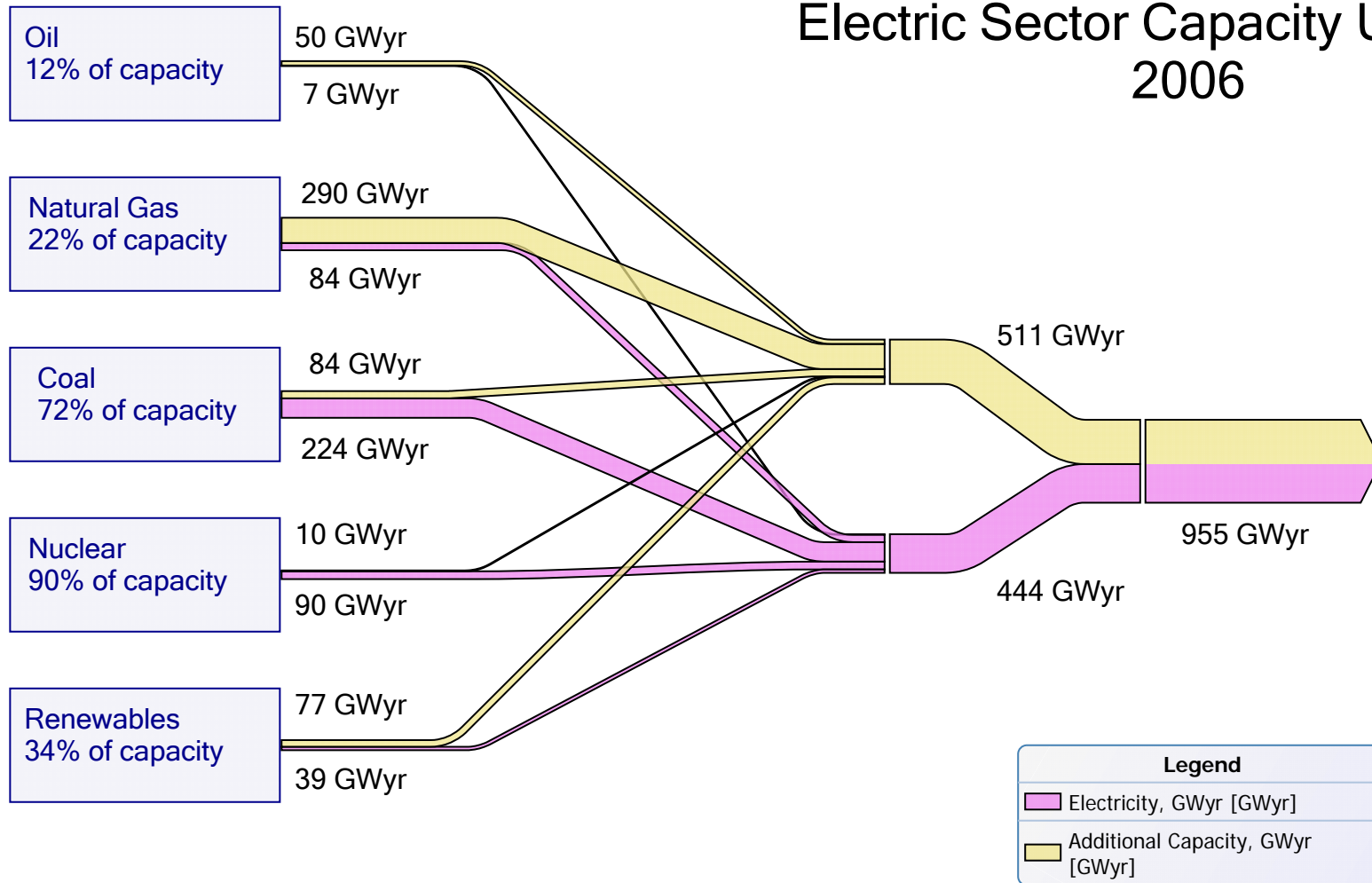

US Residential Energy Consumption 2001

Values in quadrillion BTU
unless otherwise noted

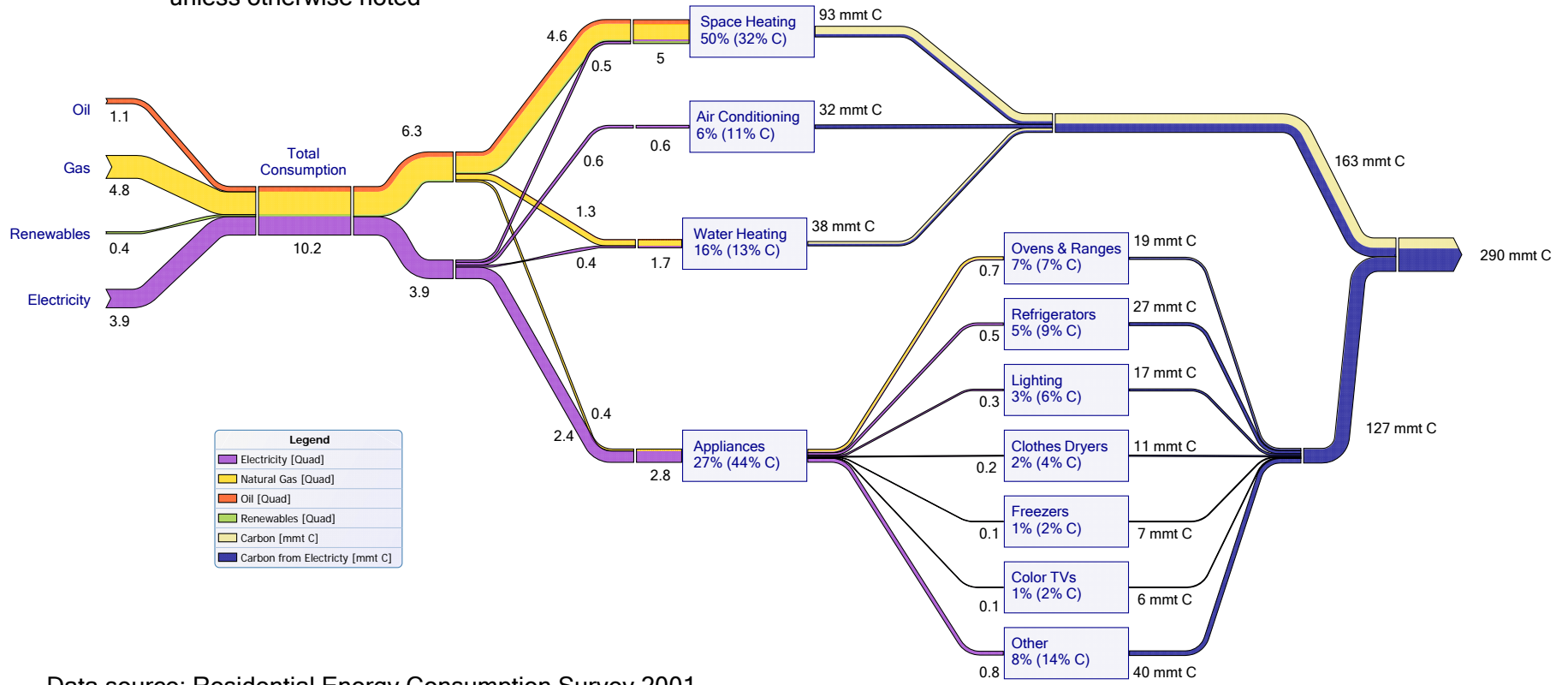

Data source: Residential Energy Consumption Survey 2001

US Commercial Building Energy Consumption 1999

Values in quadrillion BTU
unless otherwise noted

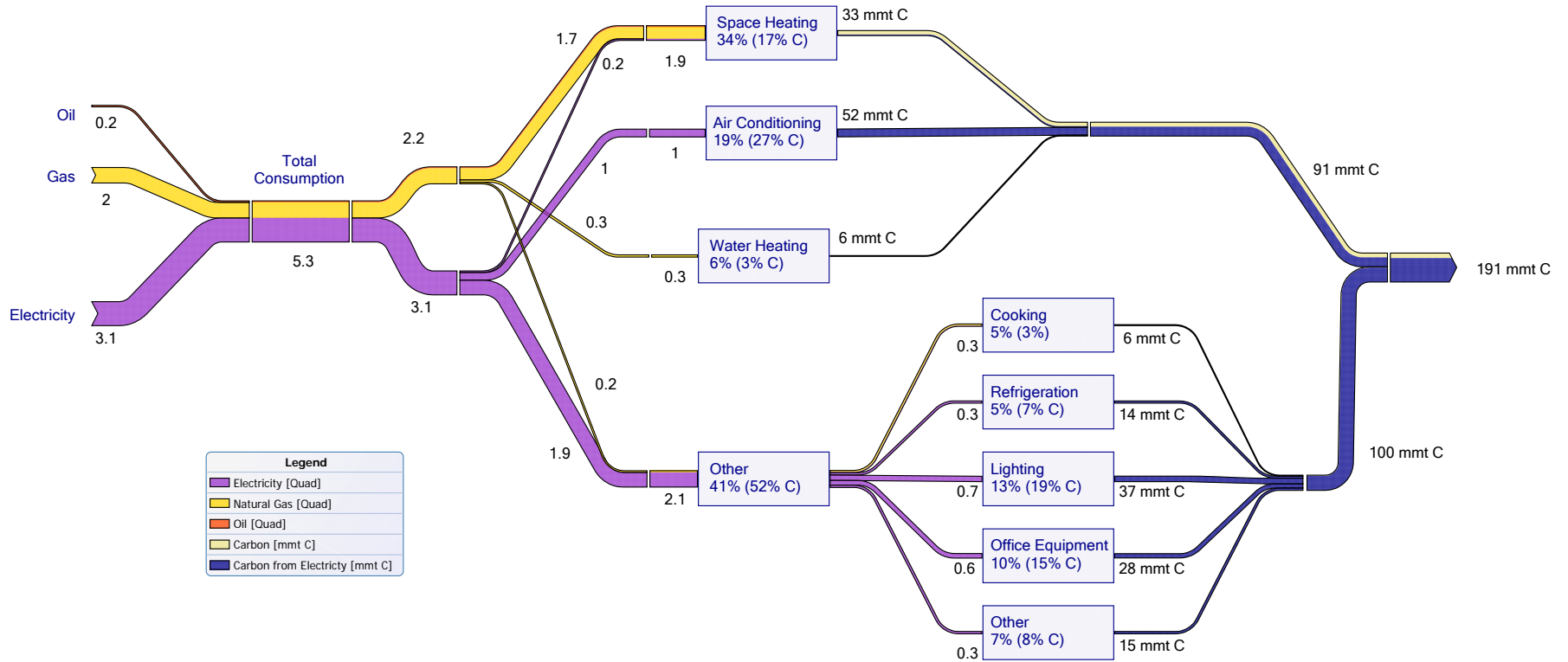

Data source: Residential Energy Consumption Survey 2001

US Industrial Energy Use 1998

All figures are in quadrillion BTU

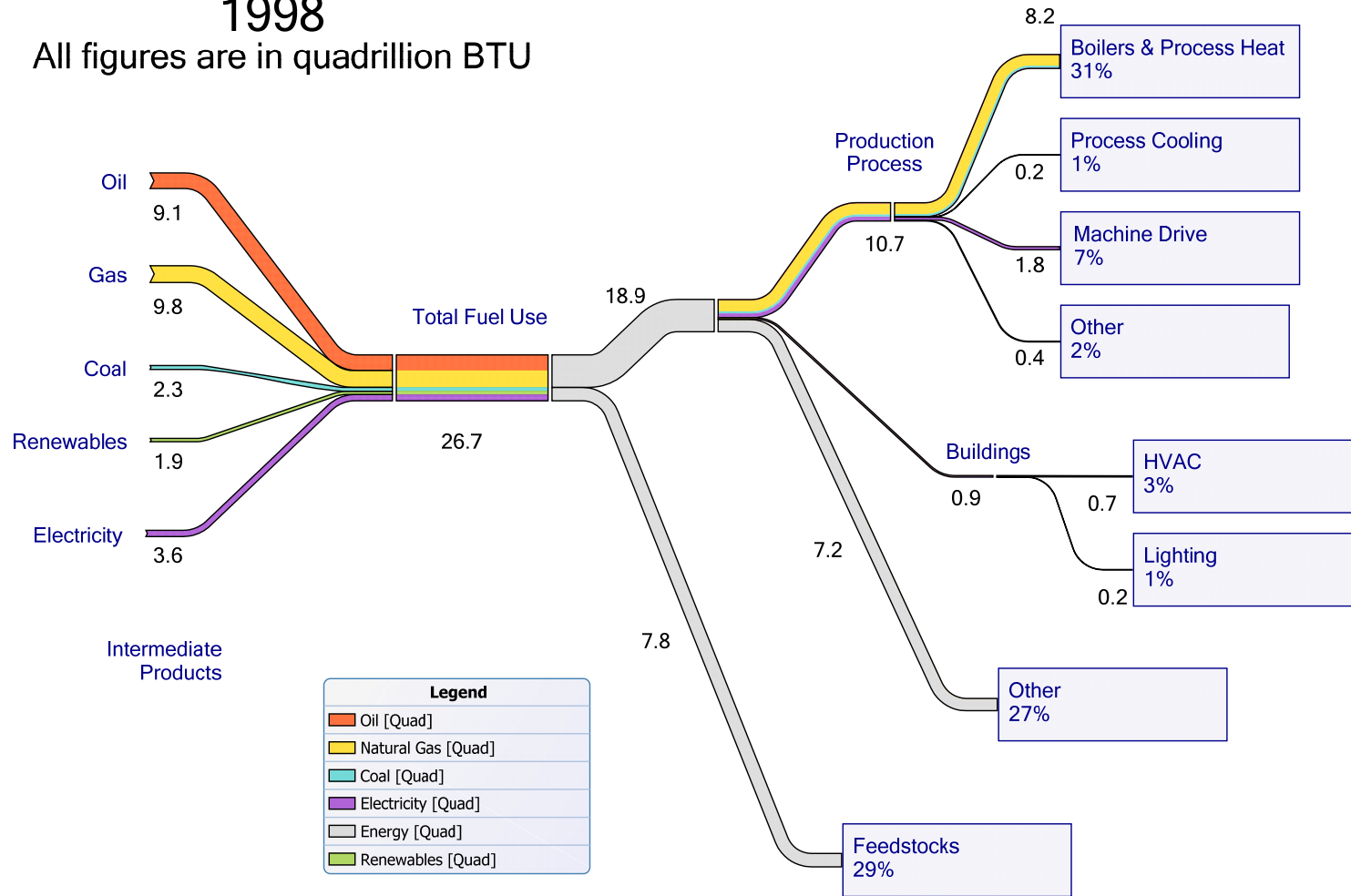

Data sources: Annual Energy Review 2006, Manufacturing Energy Consumption Survey 1998
CCSPP 1d

US Manufacturing Energy Consumption, 2002

